

FOR INDOOR USE!

🇬🇧 Anodized aluminum stand with 8 pcs. slanting A4 polycarbonate brochure holders. For indoor use.

🇩🇪 Eloxiertes Aluminium Ständer mit 8 Stück A4 Prospekthalter, schräg, aus Polycarbonat hergestellt. Für den Innenbereich.

🇩🇰 Eloxeret aluminiumsstander med 8 stk. skrå A4 polycarbonat brochureholdere. Til indendørs brug.

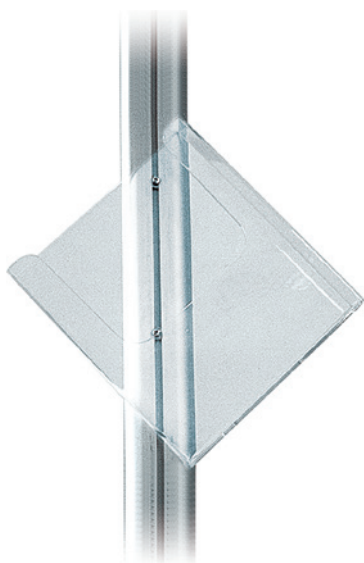

8 x A4
brochure
holders

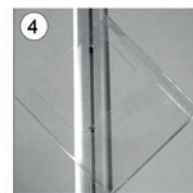
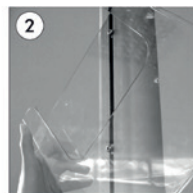
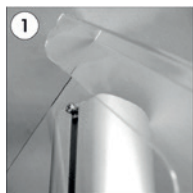
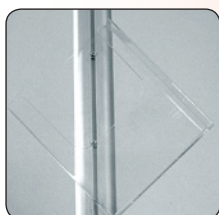
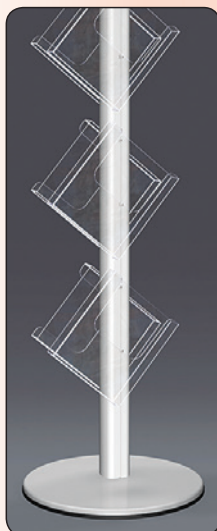
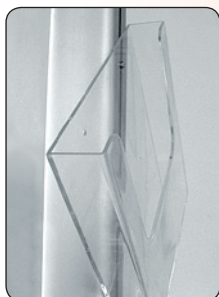
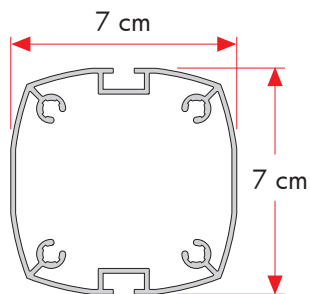
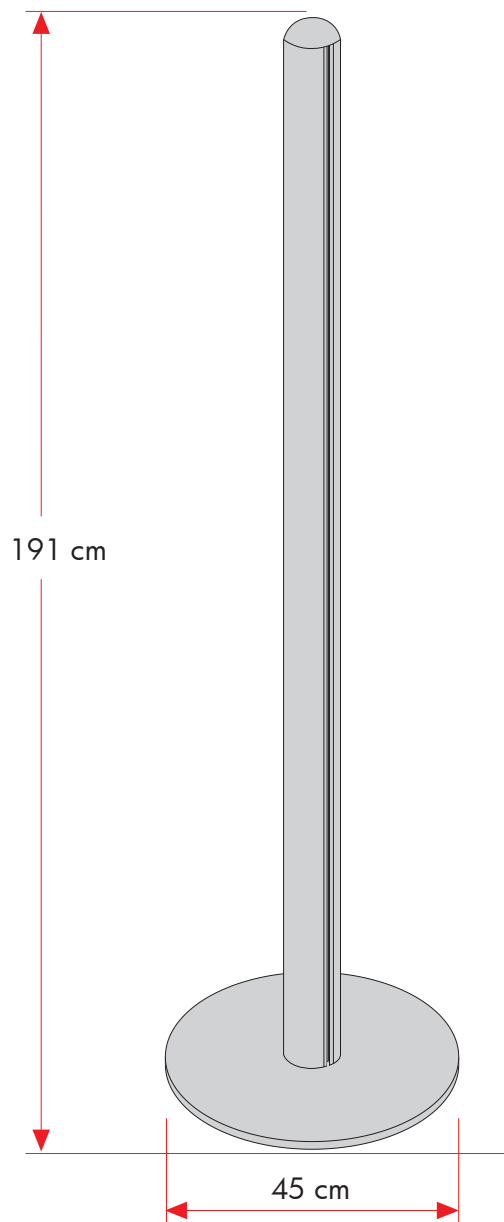

• Slide the connectors of the transparent shelves through the pole channel.
• Mutter an der transparenten Ablage in die Kanal am Mast durchstecken

• Place the transparent shelf on desired position by fixing the connectors.
• An der Wunschhöhe durch Schrauben an den Ablage fest ziehen.



Model	Art. no.	Capacity	Colour	Total W x H	Base	Weight	Pallet size and quantity
922	2876	8 x A4	Alu / Acrylic	45 x 190 cm	Ø 45 cm	25 kg	80 x 120 x 220 cm 20 pcs.